

Plan View Elevation

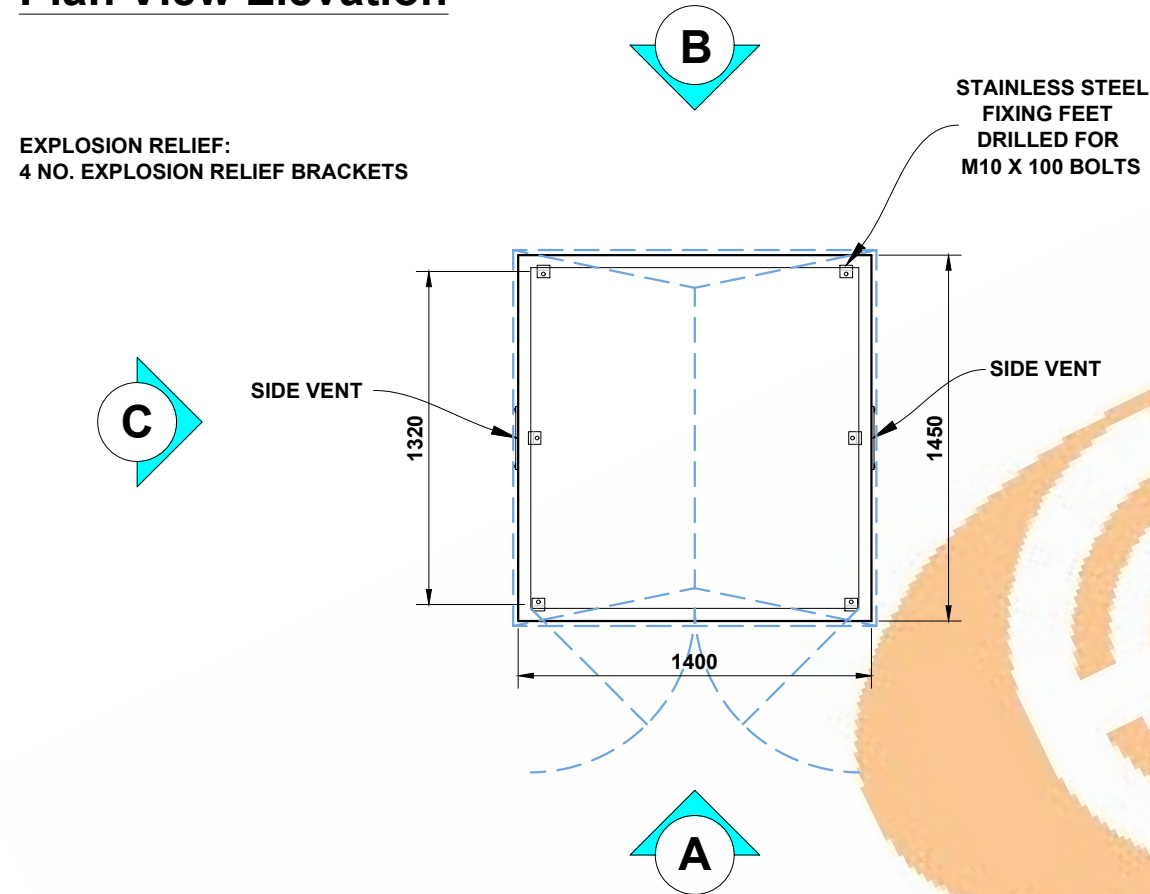

Elevation (A) (front)

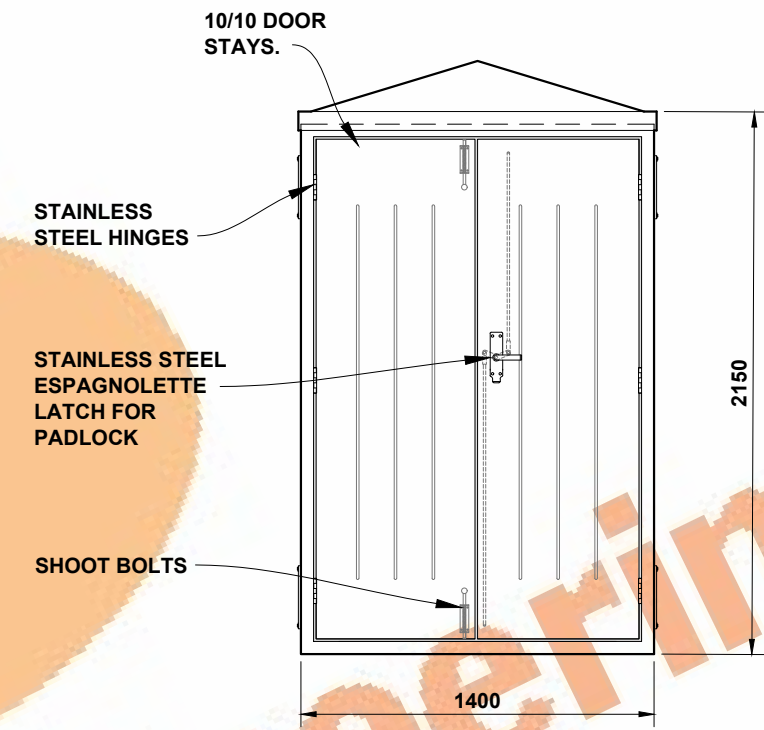

Elevation (C) (l/h side)

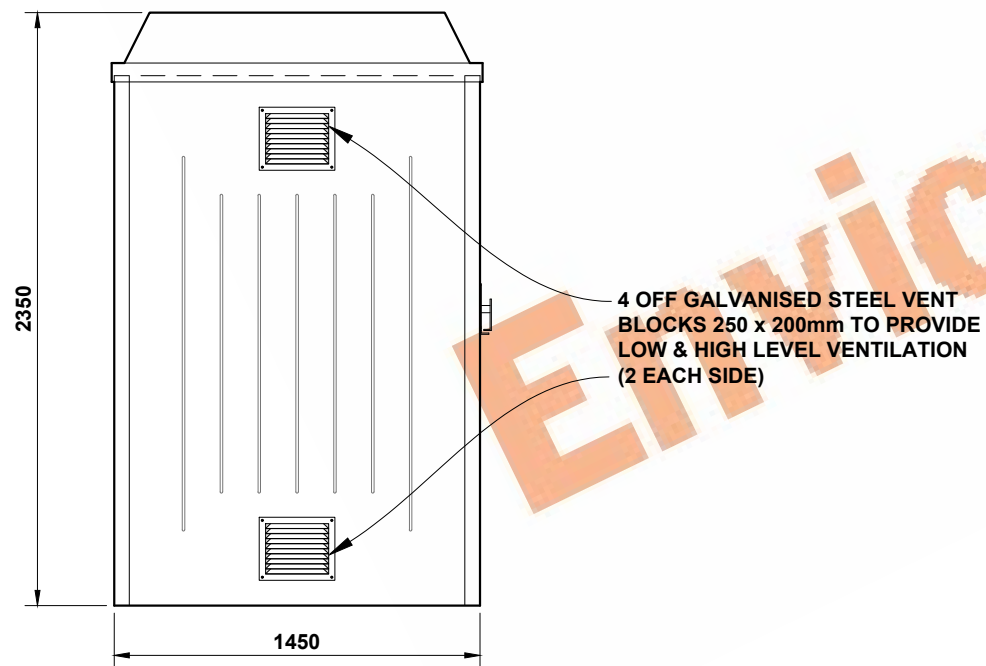

Elevation (B) (rear)

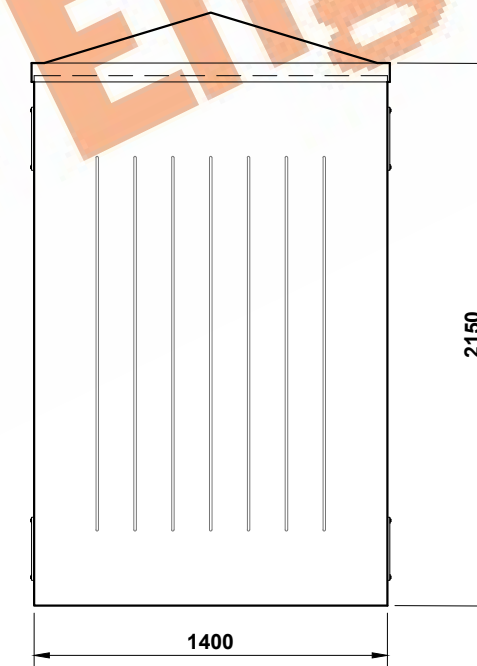

Elevation (D) (r/h side)

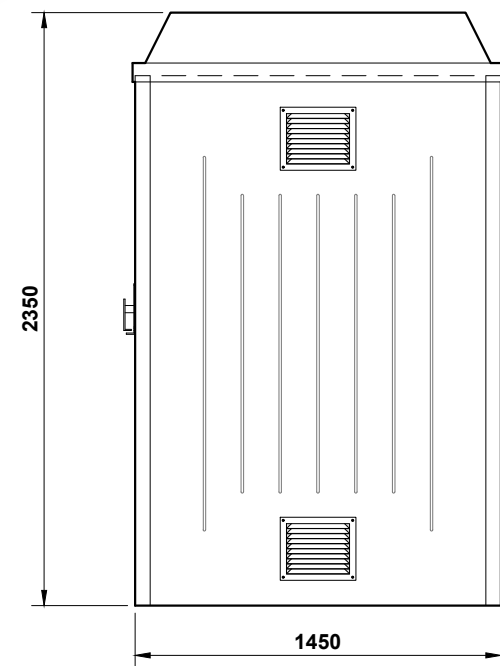

THE DRAWING AND DESIGN IS THE PROPERTY OF ENVICO ENGINEERING LTD. AND WITHOUT THE WRITTEN CONSENT OF ENVICO ENGINEERING LTD. MAY NOT BE COPIED IN WHOLE OR IN PART OR COMMUNICATED TO A THIRD PARTY OR USED FOR ANY PURPOSE.

Envico Engineering Limited

Tel : 01792 794 619
Fax : 01792 793 532

Nantffyn Road (South), Enterprise park, Llansamlet
Swansea, SA7 9RG, South Wales.

INTERNAL WIDTH : 1290mm

INTERNAL DEPTH : 1340mm

INTERNAL HEIGHT : 2150mm

APPROX. WEIGHT : 000kg

Date : 14/02/2017

Drawn By : D O'Malley

GRP HOUSING : TRANSFORMER TYPE TR4

Drawing Scale : Not To Scale

Drawing No : TR4

Rev :